

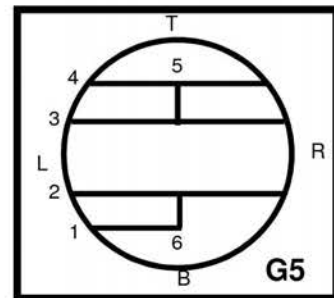

## STANDARD SHAPES FOR HEAT EXCHANGER GASKETS

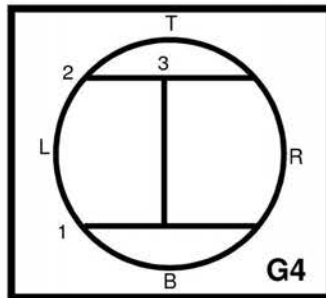

## STANDARD SHAPES FOR HEAT EXCHANGER GASKETS

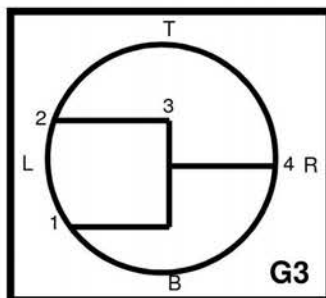
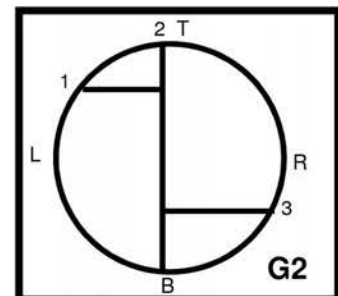
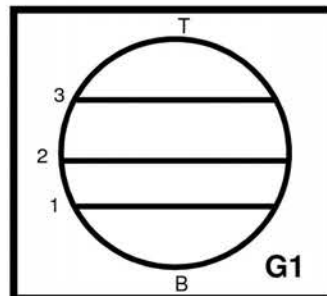
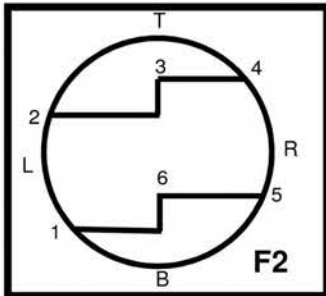
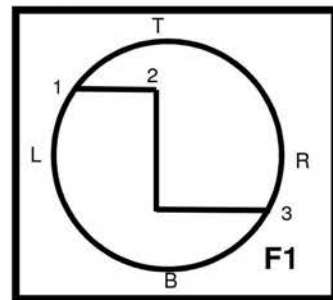
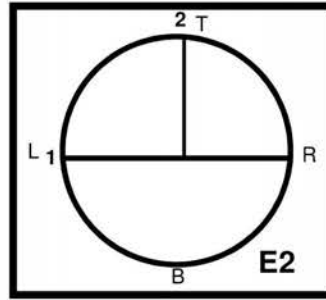
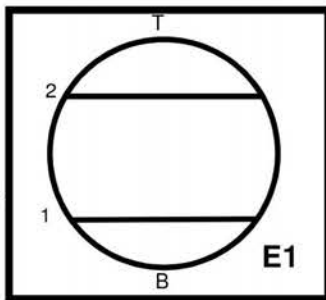
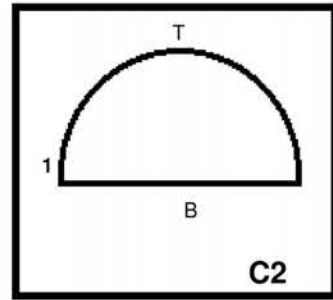
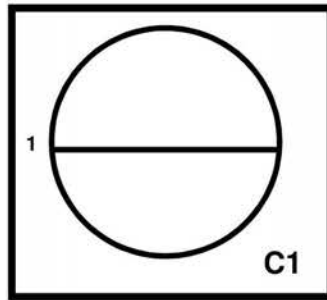
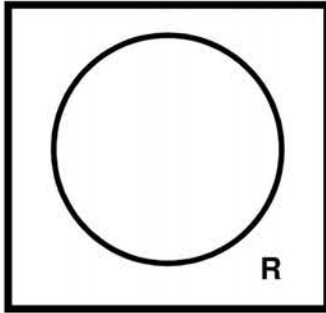
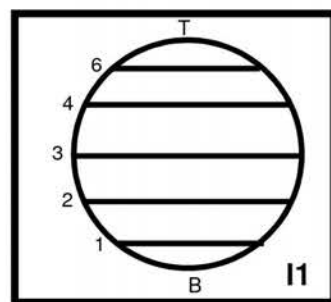
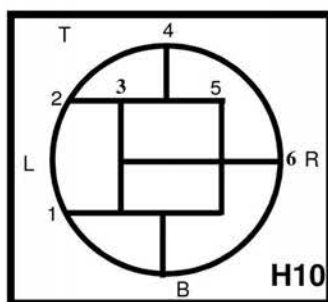
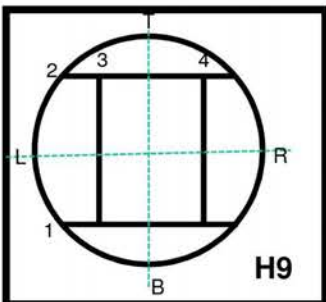
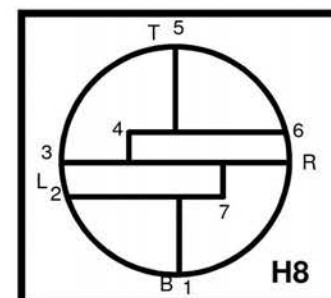
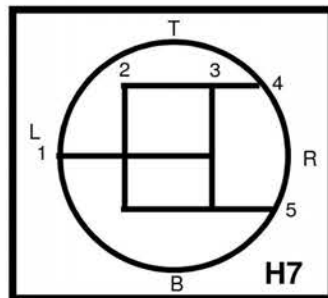
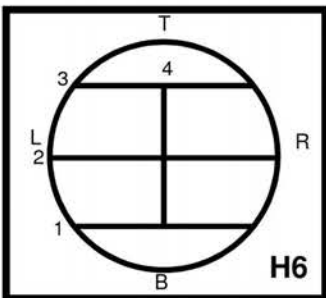
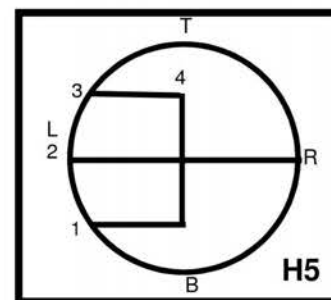
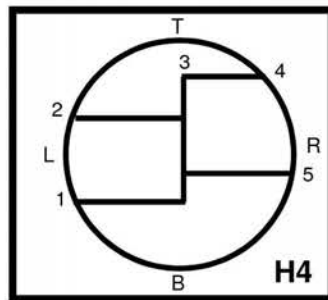
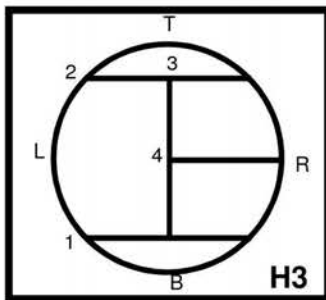
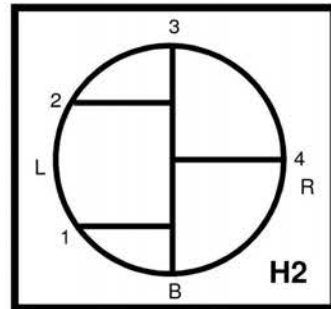
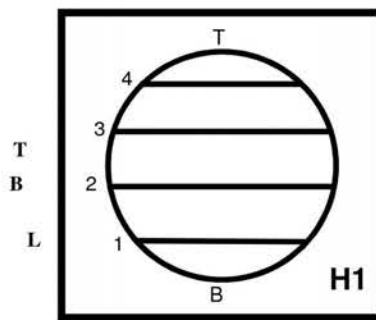
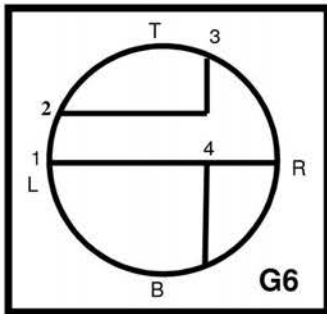



## STANDARD SHAPES FOR HEAT EXCHANGER GASKETS

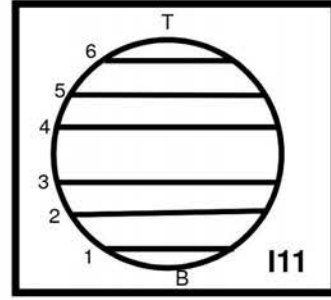
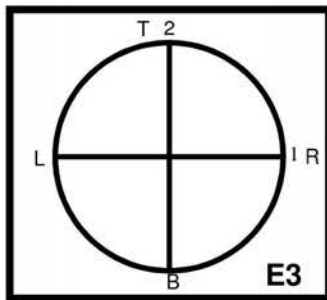
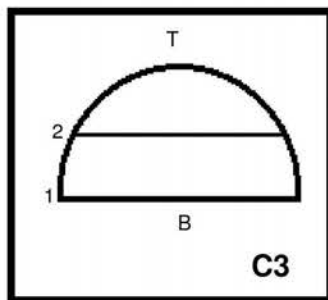
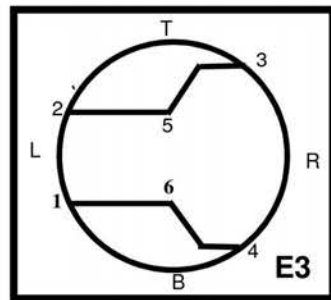
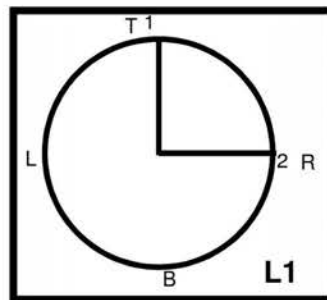
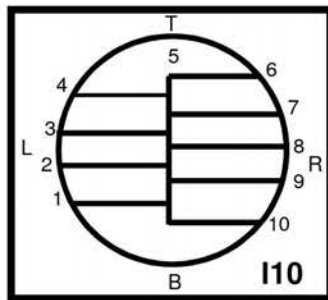
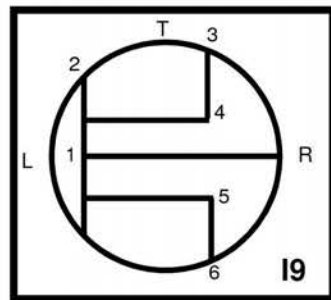
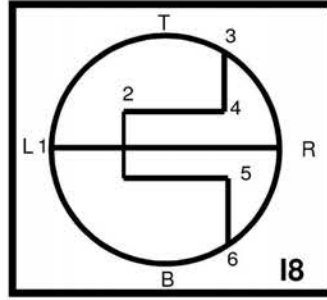
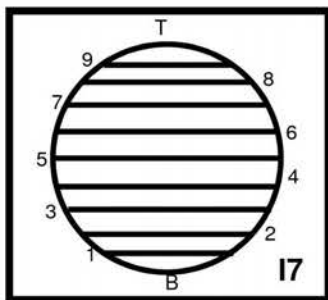
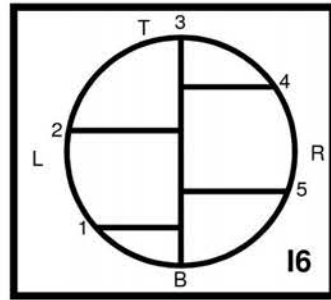
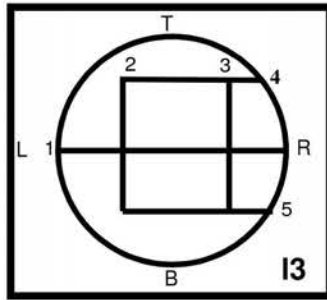
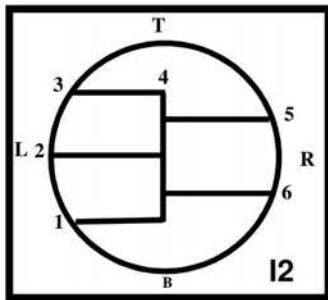



# STANDARD SHAPES FOR HEAT EXCHANGER GASKETS

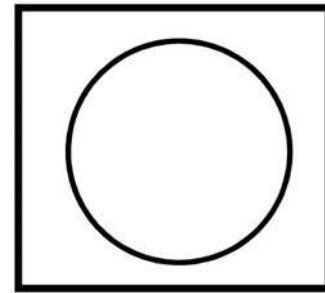
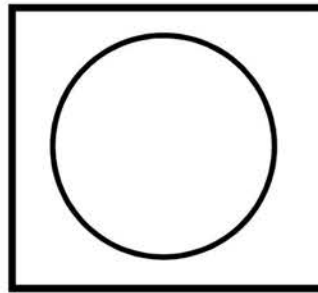
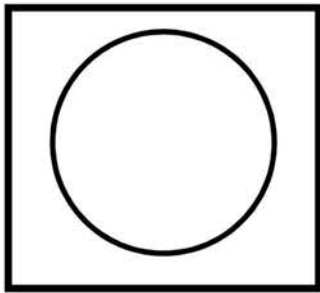
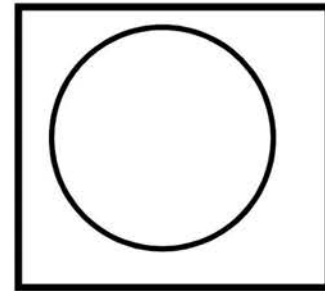
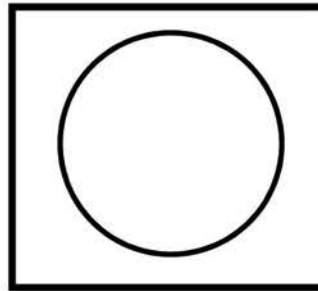
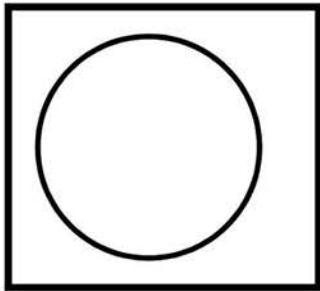
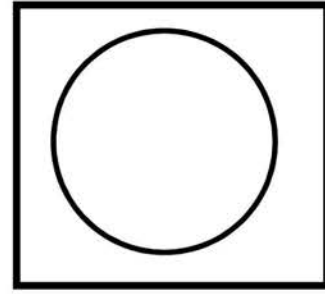
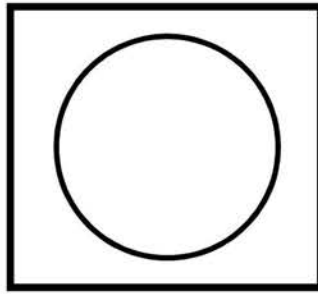
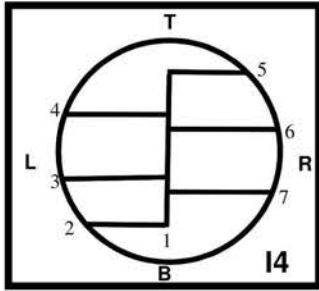



## STANDARD SHAPES FOR HEAT EXCHANGER GASKETS

INSTRUCCIONES PARA EL CHEQUEO DE LOS EMPAQUES PARA  
INTERCAMBIADOR

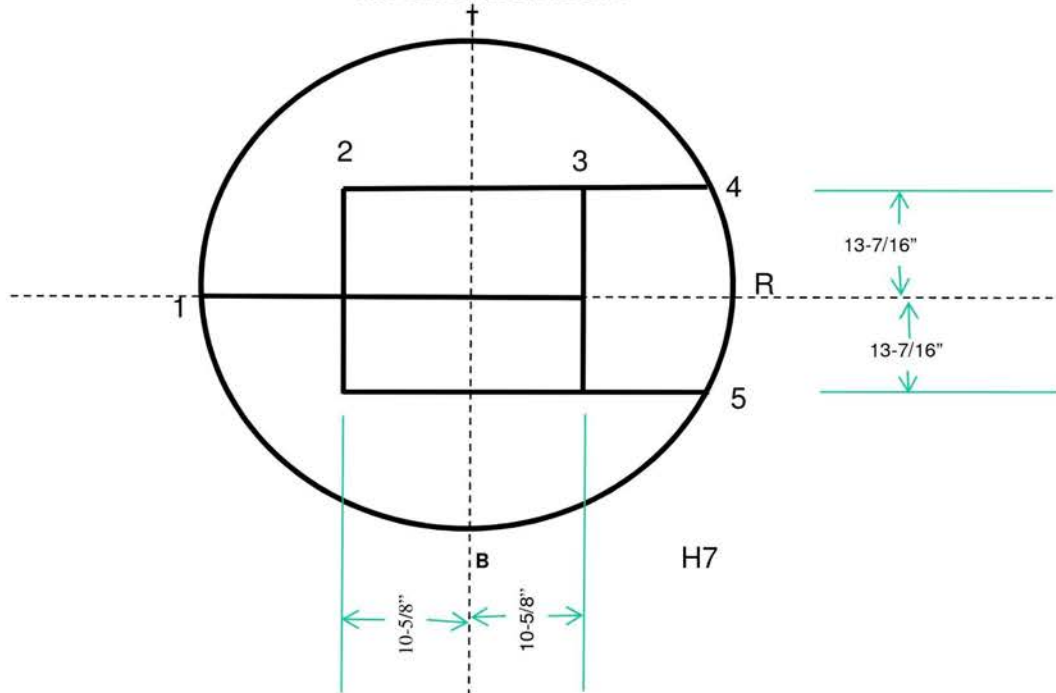

### C OF GASKET TO C OF RIB (CENTRO DEL EMPAQUE AL CENTRO DE LA DIVISION)

Todas las distancias se toman con relación al centro del empaque (líneas punteadas)

Para este caso el centro de las divisiones 2 y 3 (RIBS) están a la misma distancia del centro del empaque, igual que las divisiones 4 y 5, la división 1 es simétrica o sea que está exactamente en el centro del empaque, por lo tanto no se establece ninguna distancia en la información del catálogo.

La mejor forma de comprobar las medidas es colocar el empaque sobre una superficie plana, dividir el diámetro exterior (OD) por 2, y colocar un marca tanto en la horizontal como en la vertical, y a partir de esta marca tomar las distancias a cada una de las divisiones (RIBS).

**NOTA: Las letras L, R, T, B, corresponden a la orientación de las divisiones, para algunos empaques se debe especificar hacia que lado esta corrida la división.  
L=Left (Izquierda), R=right (derecha), T=Top (arriba) y B=bottom (abajo)**



## STANDARD SHAPES FOR HEAT EXCHANGER GASKETS

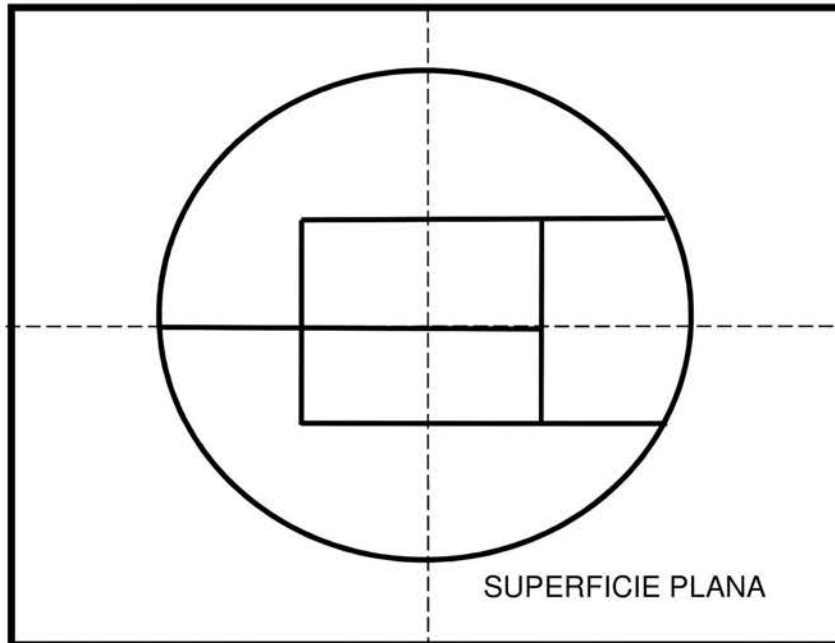

### GLOSARIO

- ID= INSIDE DIAMETER** (Diámetro interno)  
**OD=OUTSIDE DIAMETER** (Diámetro Exterior)  
**THICK=** Abreviatura de **THICKNESS** (Espesor)  
**FILLING=**Relleno  
**METAL DOUBLE JACKETED** = metal doble enchaquetado  
**BRASS=** Bronce  
**SHAPE=** Forma  
**PARTITION=** Partición  
**RIB=** División ó Costilla  
**GASKET=**Empaque  
**HEAT EXCHANGER=**Intercambiador de calor

### INFORMACION DEL CÓDIGO QUE SE TOMO COMO EJEMPLO



## Advance Sealing Spiral Wound Gasket

### **Style SWI**

Winding with Outer and Inner Ring

Advanced Sealing's **Style SWI** Spiral Wound gasket is made up of a spiral wound sealing element with an outer guide ring that serves to center the gasket in a standard flange, and an inner ring to prevent inward buckling of the winding. It is manufactured to the dimensions of ASME B16.20 for use in ASME B16.5 and ASME B16.47 flanges.

#### **WINDING:**

Standard Metallurgy <sup>(1)</sup>	304SS or 316L SS
Standard Filler <sup>(2)</sup>	Flexible Graphite

#### **OUTER RING:**

Standard Metallurgy <sup>(3)</sup>	Carbon Steel
------------------------------------	--------------

#### **INNER RING:**

Standard Metallurgy <sup>(4)</sup>	Same metal as the winding
------------------------------------	---------------------------

#### Notes:

1. Other metals can be specified to meet the demands of your application. Available metals include 321 SS, 347 SS, Alloy 20, Hastelloy, Inconel, Monel, Nickel and Titanium.
2. Other available filler materials include PTFE, Ceramic, and Mica Graphite.
3. When not made of Carbon Steel, the usual call-out is the same as the metallurgy of the winding.
4. The inner ring may be made from a non-metallic material such as PTFE to provide chemical protection to the gasket, however PTFE will not provide protection against inward buckling.